



Coonara gas log heaters

Chateau & Hermitage Range



4.6 star energy rating



Australian made heaters



The Warmest Aussie Legend

HERMITAGE and CHATEAU SERIES



The Warmest Aussie Legend

The Coonara Hermitage and Chateau heaters are ideal for those of you who desire the beauty and atmosphere of real wood heating with the easy convenience and efficiency of gas log heating.

They combine modern electronic technology and a power balanced flue system for greater heating efficiency with a beautiful log flame. Designed and manufactured in Australia by an Aussie owned and operated company. Coonara Chateau and Hermitage gas log heaters – where tradition meets innovation.

Where TRADITION meets INNOVATION

- Aussie made
- Power balanced flue system
- Ideal for asthmatics. No room ventilation is required providing increased warmth and you will not suffer oxygen depletion in your home's atmosphere through this system
- Panoramic visual flame effect combined with glowing logs
- All electronic operation on Chateau II
- On-Off, Hi-Lo, conveniently located on upper surface panel on Chateau I and Hermitage
- No bending or kneeling to operate
- Beautiful gas flame with realistic looking logs and flame
- High performance, whisper quiet two-speed fan for greater heat distribution
- User friendly climate control available as an optional extra
- Easy, versatile installation
- Minimal clearances to combustible surfaces
- Easy, convenient and efficient heating
- Install onto flooring, no additional floor protection required
- Delayed fan start-up and switch off
- Climate Controller standard in Chateau II



4.6 star energy rating

Cover: Chateau Series II Black



CHATEAU SERIES II Inbuilt **GAS LOG** Heater

The Coonara Chateau Inbuilt Series II is ideal for those who desire the beauty and atmosphere of real wood heating with the easy convenience and efficiency of gas log heating.

Combining modern electronic technology and a power balanced flue system for greater heating efficiency with a beautiful log flame. Designed and manufactured in Australia by an Aussie owned and operated company.

Coonara Chateau Inbuilt Series II gas log heaters – where tradition meets innovation.

Shown with wall matched bottom panel.



Also available in Charcoal



The Warmest Aussie Legend

CHATEAU SERIES I



Pewter



Blue Metallic



4.6 star energy rating





CHATEAU SERIES I Inbuilt **GAS LOG** Heater

The Coonara pedigree of innovation has created something special.

The Coonara Chateau Inbuilt gas log heater is a heater for homeowners who desire the beauty of woodheating with the ease of gas log heating.

Colours:

Charcoal, Golden Fire Brown, Blue Metallic, Honey Glo, Matt Black, Titanium, Pewter.

Optional Stainless Steel Surround.



The PRACTICAL and VERSATILE CHATEAU Inbuilt GAS LOG Heater

The Coonara Chateau Inbuilt Gas Log Heater is an extremely practical and versatile gas log heater with multiple installation options for just about every situation.

Importantly, there is no need for an additional 'Zero Clearance Box' for heat protection of combustible walls.

The high efficiency [4 star plus rating] of the Chateau produces low surface temperatures eliminating the need for any additional heat shielding to combustible walls. Minimum clearances are only 12mm from the side and rear walls and 20mm from the top horizontal surface. These clearances are from the firebox casing NOT the heater fascia.

The Chateau can be installed into an existing fireplace or a purpose built timber surround with a vertical flue. It is also available with a horizontal flue outlet which provides for further installation options such as cutting out the plaster and stud wall to accommodate part of the firebox and using the internal console cover with the flue cowl attached to the outside wall. You can also install the Chateau completely through the wall and use the external weather cover. Both options, illustrated at right, significantly reduce the amount of floor space required.



Inbuilt Chateau installed into stud wall cavity with internal fascia surround. (Internal Installation – Inbuilt)



External weather cover with cowl for Chateau installed through the wall (External Installation – Inbuilt)



Flue cowl attached to external wall with Chateau installed into stud wall cavity



The Warmest Aussie Legend

Choose from 8 STYLISH COLOURS

Colours for the Chateau Series I & II as featured on pages 1-6.

REACH for the STARS

4.6 star energy rating 4.6 star energy rating 4.6 star energy rating



Titanium



Pewter



Charcoal



Black



Honey Glo



Blue Metallic



Stainless Steel



Golden Fire Brown

Chateau Series I & II Heating Area:

Up to 12 squares*, depending on ambient air temperatures. **Note:** Due to the nature of the printing process, colours may vary from those shown in this catalogue. Ask your dealer to show you a colour sample.



Australian made heaters



The Warmest Aussie Legend



HERMITAGE Inbuilt GAS LOG Heater

The Coonara pedigree of innovation has created something special.

The Coonara Hermitage Inbuilt gas log heater is a heater for homeowners who desire the beauty of woodheating with the ease of gas log heating.

Colours:

Charcoal, Golden Fire Brown, Blue Metallic, Honey Glo, Matt Black, Pewter and Titanium.

Pictured above with optional Blue Metallic infill panel.

HERMITAGE Freestanding GAS LOG Heater

Stunning look realistic flame and efficient performance are trademarks of the Coonara Hermitage freestanding gas log heater.

Colours:

Charcoal, Golden Fire Brown, Blue Metallic, Honey Glo, Matt Black, Pewter and Titanium.



Rear flue model



Vertical flue model



4.2 star energy rating



The **STUNNING** and **INGENIUS** HERMITAGE Inbuilt **GAS LOG** Heater

The Coonara Hermitage Inbuilt Gas Log Heater is an extremely practical and versatile gas log heater with multiple installation options for just about every situation.

Importantly, there is no need for an additional 'Zero Clearance Box' for heat protection of combustible walls.

The high efficiency [4 star plus rating] of the Hermitage produces low surface temperatures eliminating the need for any additional heat shielding to combustible walls. Minimum clearances are only 12mm from the side and rear walls and 20mm from the top horizontal surface. These clearances are from the firebox casing NOT the heater fascia.

The Hermitage can be installed into an existing fireplace or a purpose built timber surround with a vertical flue. It is also available with a horizontal flue outlet which provides for further installation options such as cutting out the plaster and stud wall to accommodate part of the firebox and using the internal console cover with the flue cowl attached to the outside wall. You can also install the Hermitage completely through the wall and use the external weather cover. Both options, illustrated at right, significantly reduce the amount of floor space required.

Heating Area*

Up to 12 squares, depending on ambient air temperatures.



Inbuilt Hermitage installed into stud wall cavity with internal fascia surround. (Internal Installation – Inbuilt)



External weather cover with cowl for Hermitage installed through the wall.



Flue cowl attached to external wall with Hermitage installed into stud wall cavity.



4.6 star energy rating

HERMITAGE & CHATEAU SERIES



The Warmest Aussie Legend

Fuel Requirements

Designed for use with Natural and LPG Gas.

Tested and approved to

Tested and approved to the most stringent quality standards for safety and efficiency. AGA approved. Certificate No. 6165G.

Coonara Warranty

All current Coonara gas heaters are warranted to be free from defects in material and workmanship under normal use and service. The warranty of the actual firebox and heat exchanger is 5 years – to the initial purchaser. All other components (except accidental breakage of door glass) are warranted for a period of 24 months. Coonara gas log fires are designed and tested for use with Coonara manufactured flue kits. The warranty contains benefits in addition to all other specific legal rights and remedies which the purchaser may have under statute. Refer to operating and installation instructions for full warranty statement.

INTERNAL INSTALLATION – INBUILT

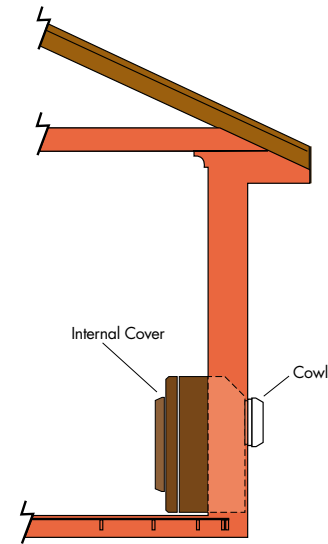

Hermitage Depth:
Internal Fascia Cover: 210mm (Brick Veneer)
Internal Fascia Cover: 350mm (Weatherboard)

Chateau Depth:
Internal Fascia Cover: 295mm (Brick Veneer)
Internal Fascia Cover: 435mm (Weatherboard)

EXTERNAL INSTALLATION – INBUILT

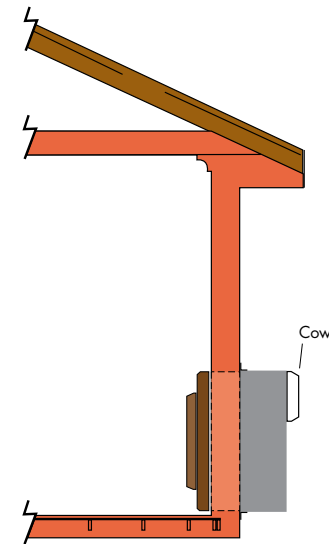

Hermitage Depth:
External Weather Cover: 170mm (Brick Veneer)
External Weather Cover: 290mm (Weatherboard)

Chateau Depth:
External Weather Cover: 290mm (Brick Veneer)
External Weather Cover: 390mm (Weatherboard)

CHIMNEY INSTALLATION – INBUILT

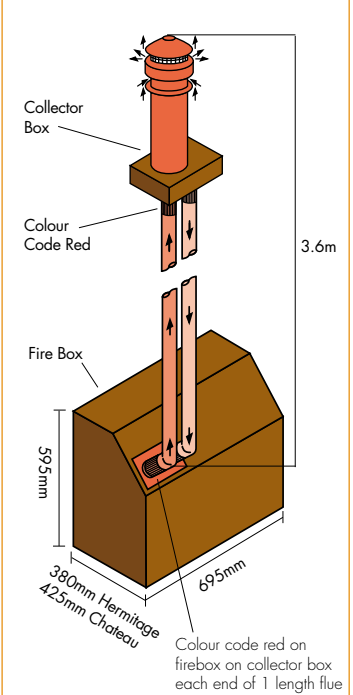

OPTIONAL CLIMATE CONTROLLER

- Ability to control room temperature – maximising comfort and energy savings.
- Programmable heating levels to enhance comfort control.
- Large easy to read backlit LCD screen.
- Powered by 2x AA batteries for approximately 12 months of operation
- Full seven-day program capability



VERTICAL INSTALLATION – FREESTANDING

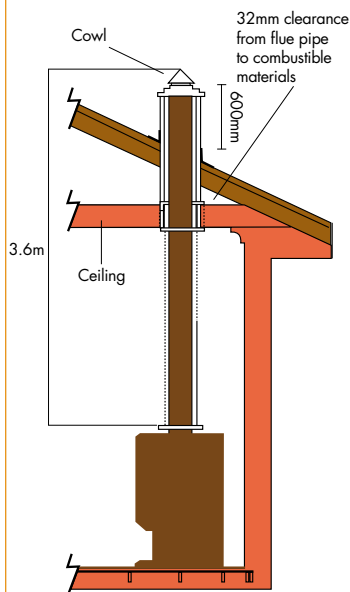

THROUGH THE WALL INSTALLATION – FREESTANDING

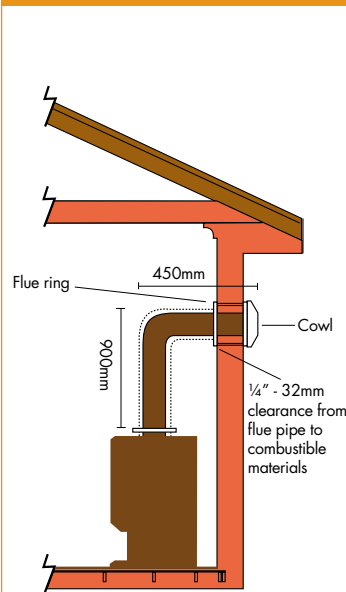

THROUGH THE WALL HORIZONTAL INSTALLATION – FREESTANDING

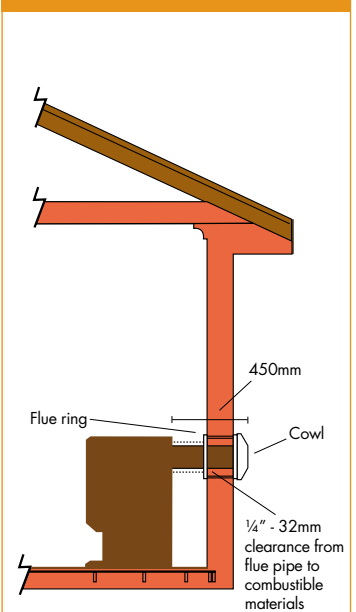

Shamick Sheetmetal.
Celebrating over
30 years of
manufacturing
in Australia



Australian made heaters

CHATEAU AND HERMITAGE GAS LOG HEATERS TECHNICAL SPECIFICATIONS

		HERMITAGE CONSOLE	HERMITAGE INBUILT	CHATEAU SERIES I	CHATEAU SERIES II
HEATING CAPACITY UP TO SQUARES SQUARE METRES*		12 120	12 120	12 120	12 120
EFFICIENCY RATING MEGAJOULES @ MAXIMUM SETTING		83% 33	83% 33	83% 33	83% 33
STAR RATING		4.2	4.6	4.6	4.6
FIRE BOX DIMENSIONS	HEIGHT (mm)	N/A	595	595	595
	WIDTH (mm)		695	695	695
	DEPTH (m)		355	435	435
OVERALL DIMENSIONS	HEIGHT (mm)	745	715	715	680
	WIDTH (mm)	600	855	800	1000
	DEPTH (m)	475	510	465	480
FASCIA DEPTH (mm)		N/A	35	35	40
FLUING OPTIONS	VERTICAL	YES	YES	YES	YES
	HORIZONTAL	YES	YES	YES	YES
	THROUGH WALL	YES	NO	NO	NO
CLIMATE CONTROLLER		OPTIONAL	OPTIONAL	OPTIONAL	STANDARD
NATURAL GAS & LPG		YES	YES	YES	YES
DESPATCH WEIGHT (kg)		74	84	81	88

INBUILT SPECIFICATIONS	NATURAL	LPG GAS
GAS INPUT: HIGH	33Mj	33Mj
GAS OUTPUT: HIGH	7.6kW (26Mj)	7.6kW (26Mj)
GAS INPUT: LOW	23Mj	23Mj
GAS OUTPUT: LOW	5.2kW (18Mj)	5.2kW (18Mj)
STAR RATING	4.6	4.6
AVERAGE ANNUAL CONSUMPTION	13,424Mj	13,424Mj
EFFICIENCY	83%	83%
BURNER PRESSURE: HIGH	1.0KPA	2.6KPA
BURNER PRESSURE: LOW	0.48KPA	1.30KPA
A.G.A. APPROVAL	6165G	6165G

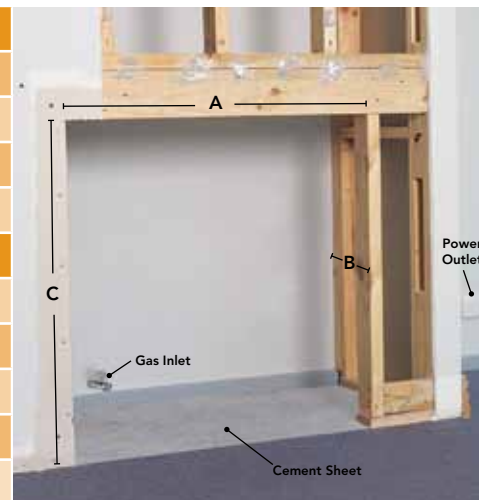

HERMITAGE
A) 740mm
B) 400mm
C) 640mm
CHATEAU
A) 740mm
B) 500mm
C) 640mm
CHATEAU SERIES 2
A) 740mm
B) 500mm
C) 640mm

- Gas Inlet to be 1/2" M/i BSP
- Power Outlet right hand side
- Cement Sheet required

***IMPORTANT:** Heating areas provided are based on open plan living areas and 2.4 metre ceiling height. Note: Lack of insulation, large window areas and cathedral ceilings reduce heating effectiveness.

Your Legendary Coonara dealer is:



14-18 Research Dve, Croydon Sth. 3136
Tel: (03) 9737 5300 Fax: (03) 9761 6455
A.B.N. 61 007 251 569
www.shamicheating.com.au



Shamic Sheetmetal (Aust) Pty Ltd proudly supports the activities of Landcare Australia through its membership of the AHHA



 Australian made heaters